



---

# INTERNATIONAL FIRE CONSULTANTS LTD

---

## COMMERCIAL IN CONFIDENCE

*This document is provided for the purpose of demonstrating compliance with the appropriate performance levels required by a designated third party. It should not be divulged to any other parties without the approval of the client named below. This document remains the property of the client.*

## IFC FIELD OF APPLICATION REPORT PAR/12033/01

### Field of Application of TriSound dB+ FD30 Timber-Based Three Layer Door Leaves Installed in Timber Frames

Prepared on behalf of: Acoustic and Fire Door Solutions Ltd  
3 Esplanade  
Broughty Ferry  
Dundee  
DD5 3EL

*NOTE: This report should not be manipulated, abridged or otherwise presented without the written consent of International Fire Consultants Ltd*

Issued – July 2012  
Valid until – July 2017

## ISSUE RECORD

Issue	Date	Recipient	Comments
Original	23/07/12	Acoustic and Fire Door Solutions Ltd	In electronic (pdf) format

## AMENDMENT RECORD

Date	Paragraph	Amendment

<b>Revision</b>	PAR/12033/01					
Author	DC					
Reviewer	DJI					

# CONTENTS

<b>1. INTRODUCTION</b>	<b>4</b>
<b>2. TEST EVIDENCE</b>	<b>4</b>
<b>3. SCOPE OF APPROVAL</b>	<b>4</b>
3.1 DOORSET CONFIGURATION	4
3.2 MAXIMUM ASSESSABLE DOOR LEAF SIZES	5
3.3 TRANSOMMED OVERPANELS	5
3.4 DOOR LEAF AND OVERPANEL SPECIFICATION	5
3.5 FRAMES	7
3.6 GLAZING APERTURES	8
3.7 HARDWARE	9
3.8 INSTALLATION, SUPPORTING CONSTRUCTION AND DOOR EDGE GAPS	9
3.9 INTUMESCENT SEALS	10
3.10 AMBIENT TEMPERATURE SMOKE/ACOUSTIC SEALS	10
<b>4. CONCLUSION</b>	<b>11</b>
<b>5. LIMITATIONS</b>	<b>11</b>
<b>6. VALIDITY</b>	<b>12</b>
<b>APPENDIX A</b>	<b>13</b>
CONSTRUCTION METHOD STATEMENT	
<b>APPENDIX B</b>	<b>14</b>
FIGURE PAR/12033/01:01 GLAZING DETAILS	
<b>APPENDIX C</b>	<b>15</b>
ASSESSED INTUMESCENT SEAL SPECIFICATION	
<b>APPENDIX D</b>	<b>17</b>
FIGURES PAR/12033/01:02 TO 05 ASSESSED LEAF SIZE ENVELOPES	
<b>APPENDIX E</b>	<b>18</b>
GENERAL GUIDANCE ON INSTALLATION OF HARDWARE	
<b>APPENDIX F</b>	<b>23</b>
SUMMARY OF FIRE TEST EVIDENCE	

# 1. INTRODUCTION

This report has been prepared by International Fire Consultants Ltd (IFC) to define the field of application of TriSound dB+ timber-based three layer door leaves installed in timber frames, that are required to provide 30 minute fire resistance performance, when adjudged against BS 476: Part 22: 1987.

The methodologies used in preparing this document are based upon the guidance in BS ISO/TR 12470: 1998; 'Fire resistance tests - Guidance on the application and extension of results'.

It is proposed that variations to the tested specifications, as described in the following sections, may be accommodated into assemblies, without reducing their potential to achieve a 30 minute integrity rating, if tested in accordance with the method and criteria of BS476: Part 22: 1987. The omission of information on any components or manufacturing methods does not imply a lack of approval of those details but these would need to be the subject of a separate analysis. Only variations specifically mentioned are supported by this assessment document, and all other aspects must otherwise be as proven in tests summarised herein.

## 2. TEST EVIDENCE

The test evidence used to support this Field of Application Report is summarised in Appendix F of this report.

## 3. SCOPE OF APPROVAL

### 3.1 Doorset Configuration

The following doorset configurations are approved within the scope of this report:

Latched, Single Acting, Single leaf Doorset	LSASD <i>Note 1</i>
Unlatched, Single Acting, Single leaf Doorset	ULSASD <i>Note 1</i>
Latched, Single Acting, Double leaf Doorset	LSADD <i>Notes 1 &amp; 2</i>
Unlatched, Single Acting, Double leaf Doorset	ULSADD <i>Notes 1 &amp; 2</i>

*Note 1* Overpanels may be fitted, provided they are separated from the door leaf by a transom member.

*Note 2* Double leaf door assemblies within the scope of this Field of Application Report may have square edged or unequally rebated meeting stiles.

### 3.2 Maximum Assessable Door Leaf Sizes

The calculated envelopes of assessed leaf dimensions for each mode and configuration covered by this Field of Application Report are given in Appendix E, based upon use of the intumescent seal specification shown in Appendix D.

Leaves in double door assemblies may each be of the same width, up to the maximum width indicated in Appendix E. If leaves are both unlatched/unbolted and of unequal width, the smaller leaf must not be more than 250mm narrower than the larger leaf. This is to reduce the level of differential deflection that may otherwise occur with the varying of leaf widths. If the smaller leaf is bolted, then there is no limit on the ratio of leaf widths, (although the large leaf must still be within limitations in Appendix E), since the bolts will restrict deflection, irrespective of the leaf width. In any case, the width of the small leaf shall not be less than 300mm, since this will affect its vertical stability relative to that of the larger leaf.

### 3.3 Transomed Overpanels

Transomed overpanels are permitted across the entire range of doorset configurations. The intumescent seal specification around the overpanel perimeter shall be as defined in Appendix C. Transom members shall be in accordance with Section 3.5, and installation shall be as defined in Section 3.8.

The size of overpanels is limited to the full width of the leaf/leaves contained within the doorset and the following maximum height:

Single leaves:	2000mm high
Double leaves:	1500mm high

In all cases, the overpanel must be a single piece panel across the frame width; i.e. a "double door" overpanel shall not be used above double door leaves. Approval of an overpanel size by IFC does not indicate that such a size can be fabricated, this should be checked with the manufacturer, and will be subject to the ability of the supporting construction providing adequate restraint/support.

### 3.4 Door Leaf and Overpanel Specification

A detailed constructional specification of the basic door and overpanel construction is given below. This is based upon the test evidence detailed in Appendix F, (and is, therefore, limited to the information available from that test report), but also defines variations and tolerances, where it is considered that these will not adversely affect overall fire resistance.

Component		Species/ Product	Dimensions		Minimum Density
Core <i>Note 3</i>	Central layers	TriSound dB+ Extruded Chipboard	45mm	3no 13mm thick layers	532kg/m <sup>3</sup> <i>Note 4</i>
	Outer layers	Cork		3mm thick	200kg/m <sup>3</sup> <i>Note 4</i>
	Between pieces and perimeter timber	Therm-A-Line	2mm thick		–
	Perimeter timber	Sitka Spruce	2no 46mm wide x 32 – 38mm stiles and rails		450kg/m <sup>3</sup> <i>Note 4</i>
Facings <i>Note 3</i>		Chipboard	4mm thick		650kg/m <sup>3</sup> <i>Note 4</i>
		MDF			730kg/m <sup>3</sup> <i>Note 4</i>
Lippings <i>Note 3</i>	Hanging, closing and flush meeting edges	Hardwood	6 – 15mm thick		650kg/m <sup>3</sup> <i>Note 4</i>
	Rebated meeting edges		18 – 24mm thick, to accommodate a 12mm rebate		
Adhesives	Between layers of core	Factory supplied clamps <i>Note 3</i>	–		–
	Between layers and perimeter timber	Staples <i>Note 3</i>	–		–
	Facing to core	PVA-D3 or Apollo A7561 <i>Note 3</i>	–		–
	Lippings	Hot melt	–		–
Optional additional decorative finishes		Timber veneer, decorative plastic based laminate, PVC or paint	Maximum 2mm thick		–

*Note 3 Leaf construction to be in accordance the method statement included in Appendix A.*

*Note 4 Nominal stated density.*

The radius formed on the leading edge of double acting doors or single acting double doors, shall not remove more than 2mm thickness of lippings from the door face. The radius of pivot stiles shall suit the pivot/floor spring employed.

Square and unequal width rebated meeting stile details are approved across the range of sizes covered by this Field of Application Report for double leaf door assemblies.

### 3.5 Frames

Timber frames, to the specifications given below may be used across the complete range of approved sizes and configurations described in Appendix E, utilising the intumescent seal specifications described in Appendix D.

Material	Density	Minimum Face Width	Minimum Frame Depth	Minimum Stop Depth
Softwood or hardwood	450kg/m <sup>3</sup> <i>Note 5</i>	32mm, excluding stop <i>Note 7</i>	70mm	12mm <i>Note 8</i>
MDF	730kg/m <sup>3</sup> <i>Note 6</i>	30mm, excluding stop <i>Note 7</i>	70mm	12mm <i>Note 8</i>

*Note 5* Timber must have a minimum measured density at 12% moisture content. The timber must be straight grained and of appropriate quality in accordance with BS EN 942: 1996. The moisture content shall be 10 ± 2% for UK market, (or to suit internal joinery moisture content specification of export countries).

*Note 6* MDF to have a minimum measured density at 12% moisture content.

*Note 7* These dimensions assume that the rear of the frame is protected by the adjacent wall, (and firestopping), and that the frame does not project out from the wall. See Section 3.7 regarding projecting frames and shadow gaps.

*Note 8* The doorstop is to comprise the same material as the door frame and may be either planted and pinned using 40mm steel pins, or integral with the main door frame, providing the minimum frame thickness remains as stated.

The overall frame depth may be increased by the use of extension linings, but the joint between the main frame and the extension lining must not intrude into the plane of the door thickness. Where an integral architrave is used, the face of the door may protrude beyond the face of the wall, providing the thickness of the architrave is no greater than 10mm and it protrudes at least 15mm beyond the rear face of the door frame. This assumes that the face of the door leaf is flush with the face of the architrave.

Head/jamb joint      Mortice and tenon, or half-lapped joint, head twice screwed to each jamb **or** mitred joint which is glued with a non-thermally softening adhesive and the head twice screwed to each jamb.

Architraves      Architraves are optional and have no fire performance requirements. (See Section 3.8 regarding wall/frame gaps).

## 3.6 Glazing Apertures

### 3.6.1 Glass types

The following glass types are approved for use in the doors considered herein, which are compatible with the identified approved glazing systems given in Section 3.6.2, although some restrictions on size may be given in subsequent sections.

- 6mm thick Pyroshield Fire and Safety (Pilkington)
- 6mm thick Pyroshield II (Pilkington)
- 7mm thick Pyrostem (CGI)
- 7mm thick Pyroguard (CGI)
- 7mm thick Pyrobelite (AGC Flat Glass)
- 12mm thick Pyrobelite (AGC Flat Glass)
- 15mm thick Pyrostop (Pilkington)

Expansion allowances for all glass types shall be as recommended by the glass manufacturer.

### 3.6.2 Glazing material

The following glazing material is approved for use in the doors considered, herein, and is compatible with the identified approved glass types listed above. (See also **Figure PAR/12033/01:01** in Appendix B).

- 10 x 2mm Therm-A-Glaze 45 (Intumescent Seals) bedded on Fireglaze 30 mastic (Sealmaster)

### 3.6.3 Bead profile and installation

The approved bead size and profile, and relevant fixing details, is shown on **Figure PAR/12033/01:01** in Appendix B.

Glazing beads must be formed from good quality, straight grained hardwood, with 640kg/m<sup>3</sup> minimum density (measured at 12% moisture content). Timber should be of appropriate quality in accordance with BS EN 942: 1996 with a moisture content of 10 ±2% for UK market (or to suit internal joinery moisture content specification of export countries).

### 3.6.4 Assessed aperture sizes

Where the cloak bead detail is used apertures are created by cutting directly into the door slab and applying a 6mm thick hardwood lipping to the aperture perimeter, bonded with PVA adhesive. The lipping must be formed from good quality, straight grained hardwood, with 640kg/m<sup>3</sup> minimum density (measured at 12% moisture content). Timber should be of appropriate quality in accordance with BS EN 942: 1996 with a moisture content of 10 ±2% for UK market (or to suit internal joinery moisture content specification of export countries).



Where the flush bead detail is used the glass opening must be lined with a minimum 32mm width Sitka Spruce perimeter formed within the core on construction and must not be cut out after assembly of the blank. The joint between the core and this perimeter must be lined with 2mm Therm-A-Line.

Based upon the size of apertures tested, it is the opinion of IFC that the following limitations apply to glazed apertures in the door leaves considered herein;

Maximum area of single aperture	-	0.42m <sup>2</sup> <i>Note 9</i>
Maximum vertical length of aperture	-	1600mm
Maximum horizontal length of aperture	-	250mm
Minimum distance from leaf edge (top)	-	100mm
Minimum distance from leaf edge (sides)	-	100mm
Minimum distance from bottom of leaf	-	200mm
Minimum distance between apertures	-	150mm

More than one aperture may be included in each leaf subject to the individual limitations above, and a minimum 150mm between apertures

*Note 9* Any aperture(s) for intumescent air transfer grilles, (see Appendix B), must also be included in the total area permitted for apertures given above. Margins between apertures apply whether for glazing or grilles.

### 3.7 Hardware

Some of the various items of hardware to be used with the proposed doorsets will have a positive contribution to the overall performance ('essential hardware') and others are classed as 'non-essential'. However, in all cases it must be ensured that choice of items, or their installation within the assemblies, does not have a detrimental effect upon their achievement of the required period of fire resistance.

General guidance for all items of hardware is outlined in Appendix E, based upon the range of items tested. All hardware beyond the scope of the general guidance must have been subjected to fire resistance testing, and/or assessed by a notified body to support its use in doors of a similar construction to that proposed.

### 3.8 Installation, Supporting Construction and Door Edge Gaps

The frames must be fixed back to the supporting construction with steel fixings at centres not exceeding 600mm on the vertical edges (minimum 200mm from the top and bottom), and a minimum of one fitted centrally across the width of the frame head of double doors. Screws shall be of sufficient length to penetrate the wall by at least 40mm, and shall be positioned such that they are not exploited by charring of the frame, irrespective of the direction of test exposure; (this may necessitate a twin line of screws). Packers shall be used at all fixing positions, although if combustible packers are employed, these must be protected by a layer of firestopping (see below) aligned near to each face of the door frame.

The supporting construction may be timber or steel stud plasterboard partition, blockwork, brickwork or concrete walls, but shall be of a type that has been tested or assessed to provide in excess of 30 minutes fire resistance, at the required size, when incorporating doorset openings. If fitted into timber or steel stud partitions, the method of forming the doorset aperture must be as tested by the partition and/or doorset manufacturer.

*Note 10 Reference to steel stud partitions is in the context of permanent elements, such as those designed and proven by the plasterboard manufacturers – this report does not approve use of the proposed doorsets in proprietary ‘demountable’ partitions, which must be subject to a full and independent appraisal of the particular system and doorsets therein.*

No part of the rear of the frame section shall be exposed once installed, (except for integral architraves) and the leaf must be flush with the face of the wall. There shall be no feature rebates or shadow gaps at the junction of the frame and wall.

The fire stopping between the supporting construction and timber frames should follow the recommendations of Table 2 in BS8214: 2008, “Code of practice for fire door assemblies”, using a product proven in such timber applications, and with reference to the correct depth of seal to suit the width of gap between wall and frame. The firestopping shall be positioned on the plane of the door leaf (unless combustible packers are employed).

The gaps between door and frame should be 1.5–4mm; the gaps at meeting stiles should be 2–4mm. Gaps under the door(s) should not exceed 6mm for fire performance, although, if smoke control is also required, these gaps should only be 3mm, or smoke seals should be included in accordance with BS8214 (see also Section 3.10 regarding suitability of smoke seals).

The doorset design should be such that leaves are fully flush within the frame when closed. The face of leaves in double doorsets should be flush with each other at meeting stiles when closed.

### **3.9 Intumescent Seals**

The intumescent seal specifications, widths, and positions are shown in Appendix C, based upon details tested.

### **3.10 Ambient Temperature Smoke/Acoustic Seals**

Ambient temperature smoke/acoustic sealing was included in the tested doorset in the form of Norseal NOR 710 at the frame reveal/stop interface and combined intumescent and smoke seals at the meeting stiles.

Other separate or combined intumescent, acoustic and/or smoke seals (using one of the intumescent products approved in Section 3.9), that have been tested to BS476: Part 31: Section 31.1: 1983 and shown not to leak by more than 3m<sup>3</sup>/m/hr at 25Pa may be used in conjunction with the proposed doorsets to provide smoke control.

The orientation of the seals, door edge gaps, degree of hardware interruption, and leaf configuration must be as tested to BS476: Part 31: Section 31.1: 1983 to achieve the desired level of smoke control, unless these conflict with the intumescent seal widths and positions as shown in Appendix D, in which case, the latter shall take precedence.

Test evidence to BS476: Part 22: 1987 shall be available to demonstrate that the smoke seals will not adversely affect the overall fire resistance of timber doorsets, when fitted in the proposed arrangements.

## **4. CONCLUSION**

It is the opinion of International Fire Consultants Ltd that if the proposed TriSound dB+ timber-based three layer door leaves installed in timber frames were manufactured and installed within the limitations of this Field of Application Report and tested for fire resistance, they would satisfy the integrity criteria of BS476: Part 22: 1987 for 30 minutes.

## **5. LIMITATIONS**

This Field of Application Report addresses itself solely to the ability of the proposed assemblies described to satisfy the criteria of the fire resistance test and does not imply any suitability for use with respect to other unspecified criteria.

This document only considers the doorset constructions described herein, and assumes that the surrounding construction will provide no less restraint than the tested assembly, and that it will remain in place and be substantially intact for the full fire resistance period.

Where the constructional information in this report is taken from details provided to International Fire Consultants Ltd and/or fire resistance test reports referenced herein, it is therefore limited to the information given in those documents. It is necessarily dependent upon the accuracy and completeness of that information. Where constructional or manufacturing details are not specified, or discussed herein, it should not, therefore, be taken to infer approval of variation in such details from those tested or otherwise approved.

The analysis and conclusions within this report are based upon the likely fire resisting performance of a complete assembly that is manufactured and installed in accordance with this document, and offered for fire resistance testing in 'perfect' condition. In practice, management procedures must be in place in any building where the doorsets are installed, to ensure that no parts of the assembly are damaged or faulty. Further, the doorsets must open and close without the use of undue force. The edge gaps/alignment of door leaves must be in accordance with the tolerances defined, herein, when the doors are closed. Any such shortfalls in respect to the condition of the doorsets will invalidate the approval by IFC, and may seriously affect the ability of the assembly to provide the required level of fire resistance performance. Determination of what constitutes wear or damage, and any corrective actions in order to return doorsets to the required condition, should only be carried out following consultation with the manufacturer and IFC.

Where the assessed constructions have not been subject to an on-site audit by International Fire Consultants Ltd, it is the responsibility of anyone using this report to confirm that all aspects of the assemblies fully comply with the descriptions and limitations herein.

Any materials specified in this report have been selected and judged primarily on their fire performance. IFC do not claim expertise in areas other than fire safety. Whilst observing all possible care in the specification of solutions, we would draw the reader's attention to the fact that during the construction and procurement process, the materials used should be subjected to more general examination regarding the wider Health and Safety, and COSHH Regulations.

This Report is provided to the sponsor on the basis that it is a professional independent engineering opinion as to what the fire performance of the construction/system would be should it to be tested to the named standard. It is IFC's experience that such an opinion is normally acceptable in support of an application for building approvals, certainly throughout the UK and in many parts of Europe and the rest of the world.

However, unless IFC have been commissioned to liaise with the Authorities that have jurisdiction for the building in question for the purpose of obtaining the necessary approvals, IFC cannot assure that the document will satisfy the requirements of the particular building regulations for any building being constructed.

It is, therefore, the responsibility of the sponsor to establish whether this evidence is appropriate for the application for which it is being supplied and IFC cannot take responsibility for any costs incurred as a result of any rejection of the document for reasons outside of our control. Early submittal of the Report to the Authorities will minimise any risks in this respect.

## 6. VALIDITY

This assessment has been prepared based on International Fire Consultants Ltd's present knowledge of the products described, the stated testing regime and the submitted test evidence. For this reason anyone using this document after July 2017 should confirm its ongoing validity.

Prepared by:



**David Cooper BEng (Hons) MIWSc**  
Senior Engineer  
International Fire Consultants Ltd. (IFC)

Checked by:

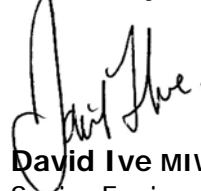

**David Ive MIWSc**  
Senior Engineer  
International Fire Consultants Ltd. (IFC)

## **APPENDIX A**

### **Construction Method Statement**

*The figures in this Appendix are not included  
in the sequential page numbering of this report*

## TriSound dB+ Acoustic Blank Construction Method Statement

Tel: +44(0)7815 589447  
Email: kshepherd@afdsl.com

### Materials

- TriSound dB+ 45mm thick 3-Ply acoustic core with Cork outer layers (nom 2000x800mm)
- Sitka Spruce (min density 450kg/m<sup>3</sup> at 12% mc) 46x38mm section perimeter timber
- 46x2mm Therm-A-Line Intumescent material
- 2no 4mm Chipboard/MDF sheets for substrates (alternatively 2 x 2no 2mm MDF sheets may be used as substrates with the outer substrates concealing the lippings - see sections 10 & 15)
- Min 20x12mm steel staples
- Apollo A7561 adhesive

### Method

#### 1. Cut Core to internal size:

- Core Height: Blank Height – 152mm – 4mm
- Core Width: Blank Width – 152mm – 4mm
- Where Fire performance is required the following conditions must be adhered to:
  - the core must only be used in the “portrait” orientation
  - When cutting the core to width it is imperative to ensure that the required amount is only trimmed from one edge of the core. If the non-cut edge requires squaring-up this can be achieved by trimming a maximum of 6mm before the remainder is trimmed from the opposite edge.
  - The core is normally supplied at 2000x800mm dimensions. If a higher and/or wider core size is required then more than one piece of core can be used provided not more than one vertical joint and one horizontal joint are introduced. Horizontal joints should be kept as close to the bottom of the door as possible. Where both horizontal and vertical joints are present, the horizontal joint should be staggered by a minimum of 100mm to avoid a “+” shaped joint. All joints should be packed with 2mm Therm-A-Line. See detail below for allowable layouts:

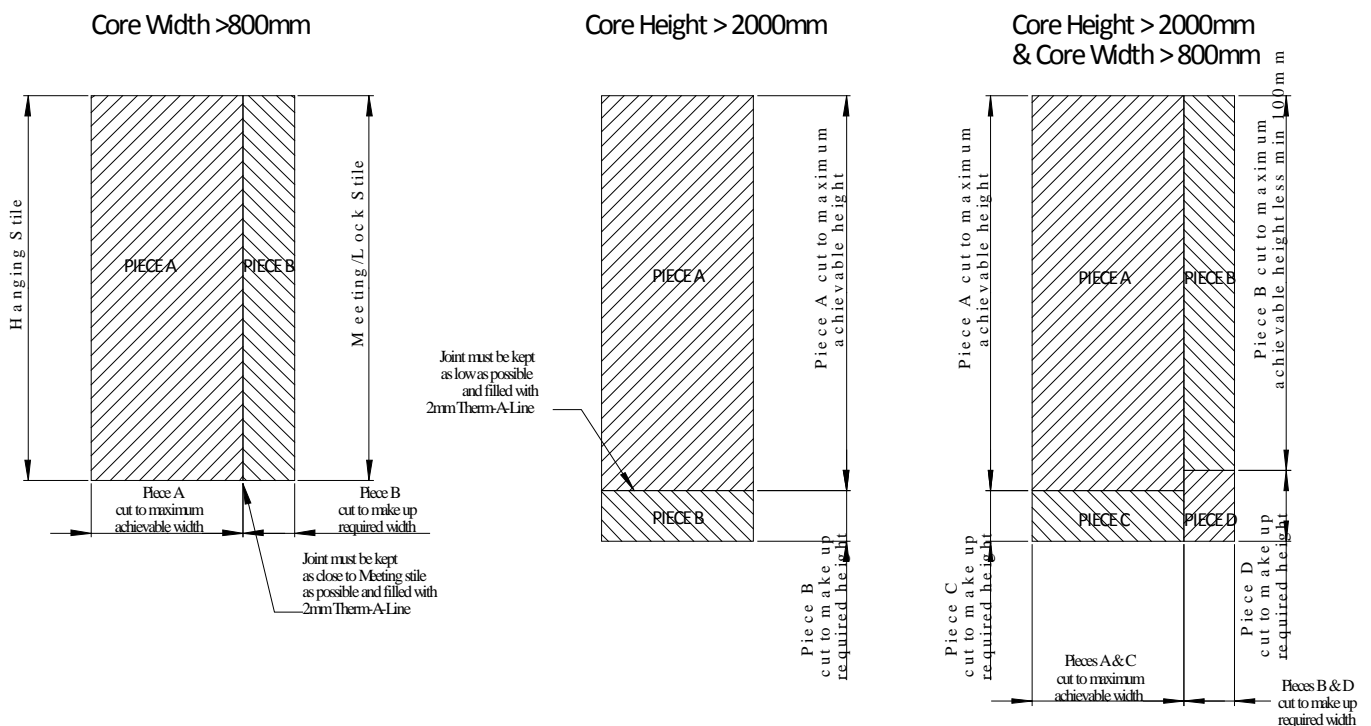

- iv. Where multiple pieces of core are used, at least one vertical row of the internal metal clamps supplied within the core must be maintained within each piece of core used. If this is not possible (e.g. due to a very narrow width piece) then a vertical row of clamps must be re-instated into the core piece from both faces one 10mm either side of the centre line (i.e. 20mm apart), with clamp positions starting 50mm from the top of the piece and centred at between 150mm and 250mm down the core piece. For more information on clamping contact Falcon/Acoustic & Fire Door Solutions Ltd.
- v. In any event the overall leaf sizes should be limited to the permissible envelope provided with the fire performance evidence.

2. Cut Perimeter Timber:

- a. Outer stiles: Blank Height
- b. Inner stiles: Blank Height – 152mm
- c. All rails: Blank Width – 76mm

3. Cut substrate

(2no 4mm substrates):

- a. Height: Blank Height + 4mm
- b. Width: Blank Width + 4mm

OR (2 x 2no 2mm substrates)

- c. Height (1&2): Blank Height + 4mm
- d. Height (3&4): Leaf Height + 4mm
- e. Width (1&2): Blank Height + 4mm
- f. Width (3&4): Leaf Height + 4mm

4. Assemble Perimeter using steel staples from both faces, in locations shown below, ensuring tight fit of timber at joints and where butted up. Gaps of > 0.5mm are unacceptable. Note that the bottom rail is not stapled.

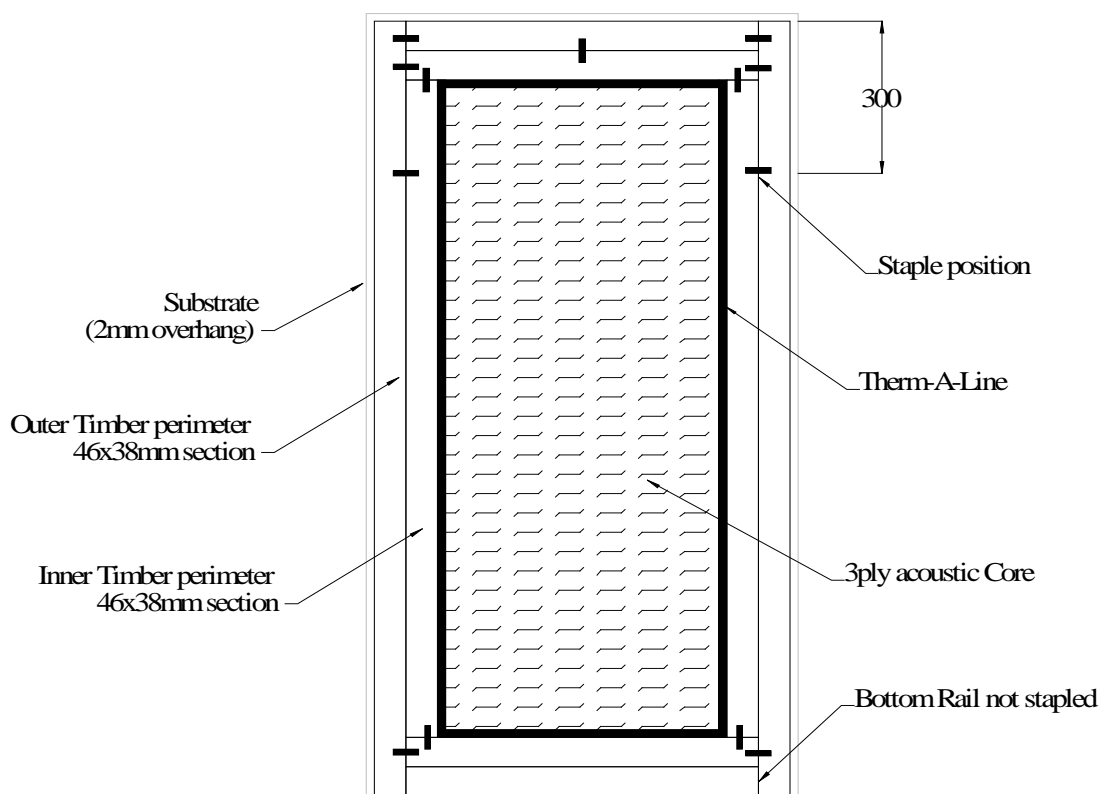

5. Coat one substrate with Apollo A7561 adhesive (140Kg/m<sup>2</sup>) and over mist with water (5% of the adhesive weight used). Avoid excessive water. Alternatively PVA-D3 may be used in lieu of the Apollo adhesive. Place (adhesive side up) on pressing platform
6. Place perimeter onto substrate with 2mm overlap all round
7. Place the bottom rail ensuring tight fit
8. Attach Therm-A-Line to internal edge of perimeter
9. Place cut-to-size core material into the perimeter
10. Coat second substrate with Apollo A7561 adhesive, mist with water and place on top of core/perimeter. Again PVA-D3 may be used in lieu of the Apollo adhesive. Where 2 x 2no MDF sheets are being used the 3<sup>rd</sup> and 4<sup>th</sup> substrate sheets are added after lipping (see section 15)
11. Press in a hot press until adhesive is cured to the handling stage. Suggested time in a hot press would normally be around 20-30 minutes but the time required will vary due to press temperature and other conditions. It is possible to use a cold press although pressing time to reach the handling stage will be significantly increased, e.g. in a 21°C environment the handling stage would normally be reached in around 75 minutes, although again this will vary due to conditions. For more information see the adhesive manufacturers Technical Data Sheet
12. Once the handling stage of curing is reached the blank can be removed from the press but handling should be kept to a minimum until full cure has been achieved. Time required to achieve full cure varies with temperature and other conditions but as a guide a blank stored in normal conditions should achieve full cure after around 24 hours.
13. Mark “Top” on the top perimeter frame.
14. Once full cure has been reached the blank can be trimmed and lipped.
15. If using 2 x 2no MDF sheets the outer substrates are added once the blank has been trimmed and lipped:
  - a. Coat the 3<sup>rd</sup> substrate sheet with Apollo A7561 adhesive and mist with water. PVA-D3 may be used in lieu of the Apollo adhesive.
  - b. Place the blank onto substrate with equal overlap all round
  - c. Coat 4<sup>th</sup> substrate sheet with Apollo A7561 adhesive, mist with water and place on top of the blank. Again PVA-D3 may be used in lieu of the Apollo adhesive.
  - d. Press in a hot press until adhesive is cured to the handling stage. Suggested time in a hot press would normally be around 20-30 minutes but the time required will vary due to press temperature and other conditions. It is possible to use a cold press although pressing time to reach the handling stage will be significantly increased, e.g. in a 21°C environment the handling stage would normally be reached in around 75 minutes, although again this will vary due to conditions. For more information see the adhesive manufacturers Technical Data Sheet
  - e. Once the handling stage of curing is reached the blank can be removed from the press but handling should be kept to a minimum until full cure has been achieved. Time required to achieve full cure varies with temperature and other conditions but as a guide a blank stored in normal conditions should achieve full cure after around 24 hours..
16. The blank can now be veneered/trimmed/primed/painted according to requirements. See the relevant Technical Manual for more information regarding use of the blank.



## **APPENDIX B**

**Figure PAR/12033/01:01**

**Glazing Details**

*The figures in this Appendix are not included  
in the sequential page numbering of this report*

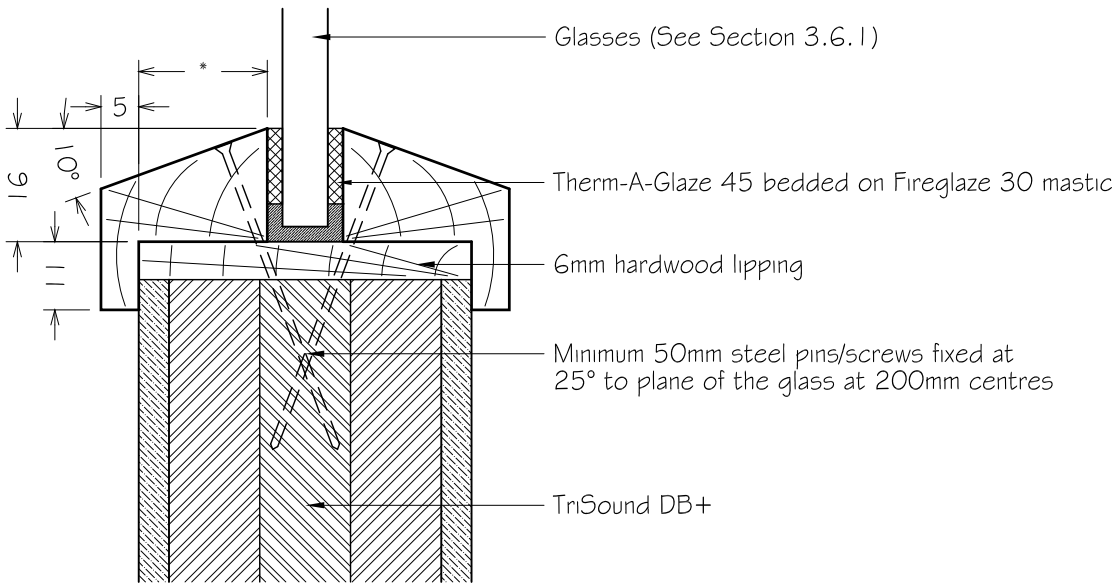

### CLOAK BEAD DETAIL

\*to suit glass thickness

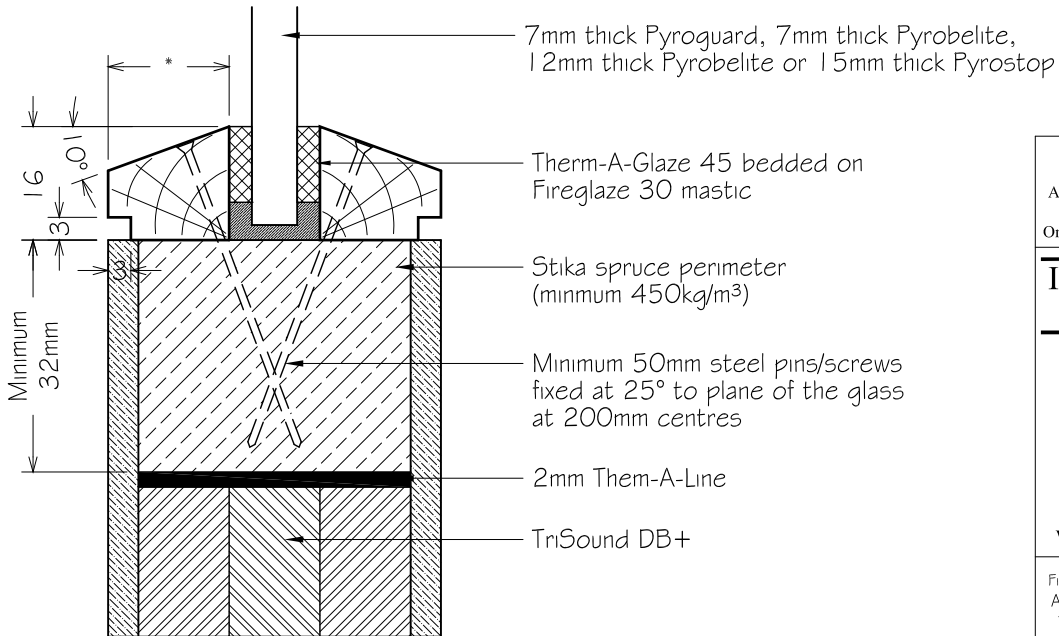

### FLUSH BEAD DETAIL

\*to suit glass thickness

This drawing is Copyright©  
Contractors must check all dimensions.  
Any discrepancies must be reported before  
work proceeds.  
Only work to dimensions stated on drawing.

#### INTERNATIONAL FIRE CONSULTANTS LTD

20 Park Street  
PRINCES RISBOROUGH  
Buckinghamshire  
HP27 9AH  
United Kingdom  
Tel: +44 (0) 1844 275500  
Fax: +44 (0) 1844 274002  
Email: ifc@intfire.com  
Website: <http://www.intfire.com>

Field of Application Report PAR/1 2033/01  
Acoustic and Fire Door Solutions Ltd  
TriSound dB+ FD30 Timber-Based  
Three Layer Door Leaves  
Installed in Timber Frames

Glazing Bead Details

Job number : 12033

Drawn by : CSP | Checked by : DJC

Not To Scale | July 2012

PAR/1 2033/01:01

## **APPENDIX C**

### **Assessed Intumescent Seal Specification**

## Intumescent Seal Specification

Location	Size and Position
Stiles/jamb	1no 15 x 4mm seal centrally fitted in the frame reveal or leaf edge
Head	2no 15 x 4mm seals fitted 10mm apart, centrally, in the frame reveal or leaf edge
Flush meeting stiles	2no 10 x 4mm seals fitted 10mm apart, centrally, in one leaf edge
Unequally rebated meeting stiles	2no 10 x 4mm seals fitted 5mm apart, centrally, in the nib of the active leaf

**Note:**

*The intumescent seals are to be pvc encased graphite based or Lorient 617. All seals should be obtained from members of the Intumescent Fire Seals Association (IFSA). Combined intumescent/smoke seals may be used, maintaining the widths specified above (and subject to the conditions outlined in Section 3.9).*

## **APPENDIX D**

**Figures PAR/12033/01:02 to 05**

**Assessed Leaf Size Envelopes**

*The figures in this Appendix are not included  
in the sequential page numbering of this report*

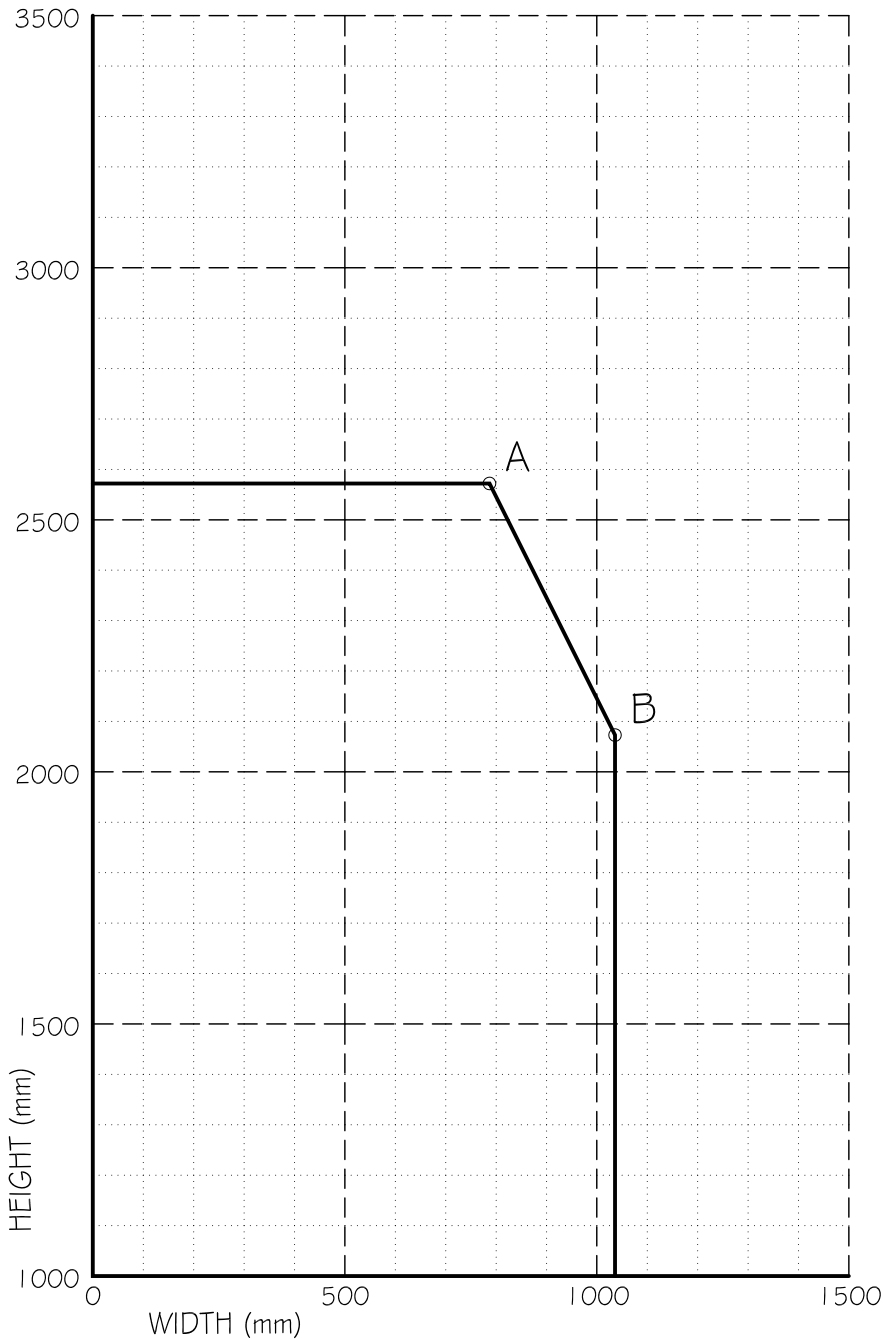

LSASD		
-----		
	A	B
Width	787	1036
Height	2572	2073

### ENVELOPE OF APPROVED DOOR LEAF SIZES

This graph represents the envelopes of approved leaf sizes for the proposed door leaf constructions and configurations. Any combination of leaf width and height that falls within the graph axes and the connecting line on the graph are approved for the specific construction.

POINT A represents the maximum leaf height and it associated width. POINT B represents the maximum leaf width and it associated height.

This figure forms part of International Fire Consultants Ltd's Field of Application Report PAR/1 2033/01, which contains full details of the assessed doorset constructions.

Configuration  
**Timber Frames**  
 LATCHED  
 SINGLE ACTING  
 SINGLE LEAF  
 WITH or WITHOUT TRANSOMMED OVERPANEL  
 REQUIRED INTEGRITY : 30 Minutes

This drawing is Copyright©  
 Contractors must check all dimensions.  
 Any discrepancies must be reported before  
 work proceeds.  
 Only work to dimensions stated on drawing.

### INTERNATIONAL FIRE CONSULTANTS LTD

20 Park Street  
 PRINCES RISBOROUGH  
 Buckinghamshire  
 HP27 9AH  
 United Kingdom  
 Tel: +44 (0) 1844 275500  
 Fax: +44 (0) 1844 274002  
 Email: ifc@intfire.com  
 Website: <http://www.intfire.com>

Field of Application Report PAR/1 2033/01  
 Acoustic and Fire Door Solutions Ltd  
 TrnSound dB+ FD30 Timber-Based  
 Three Layer Door Leaves  
 Installed in Timber Frames

Envelope of Approved  
 Door Leaf Sizes

Job number : 1 2033  
 Drawn by : C5P | Checked by : DJC  
 Not To Scale | July 2012

PAR/1 2033/01:02

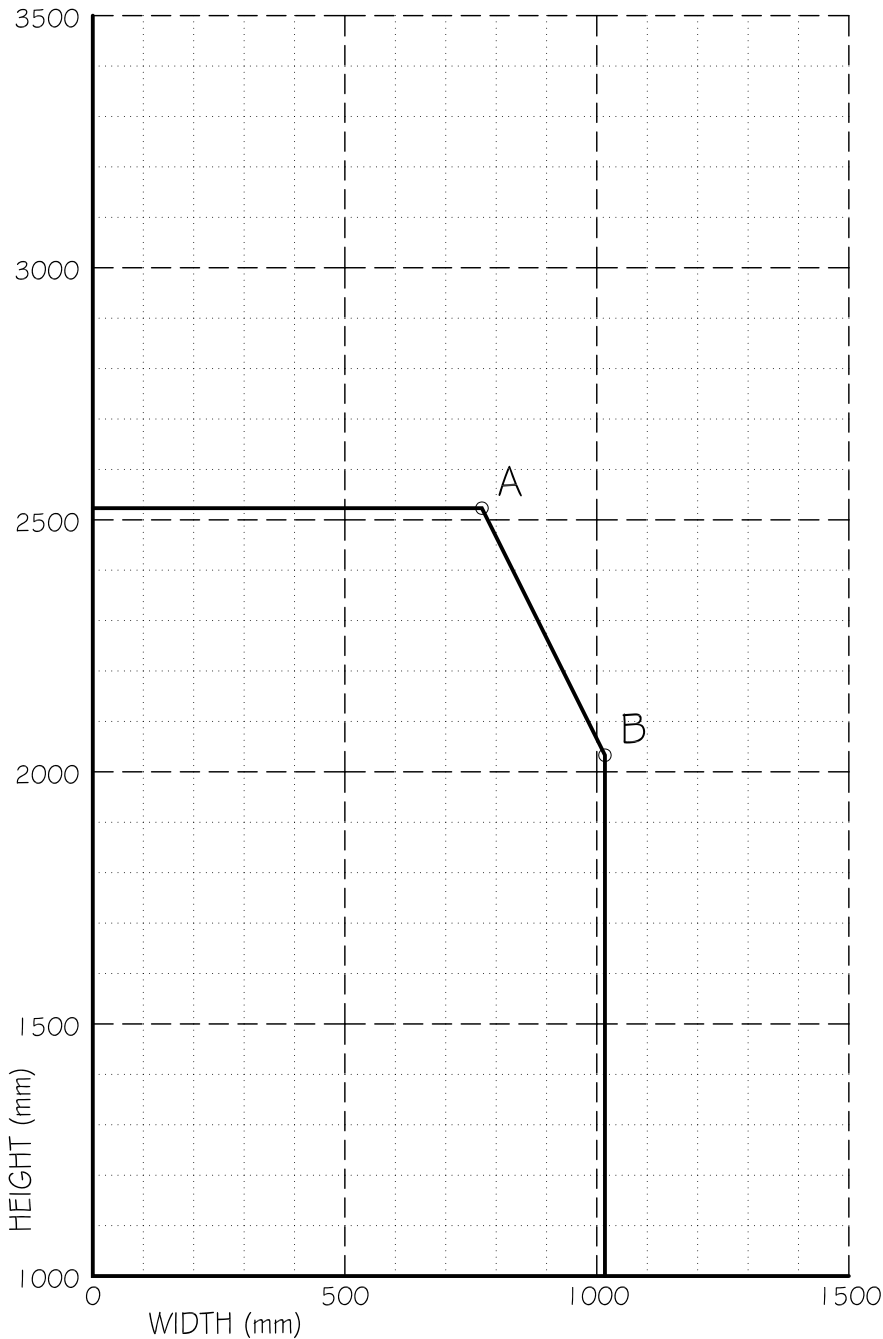

ULSASD		
-----		
	A	B
Width	772	1016
Height	2523	2033

### ENVELOPE OF APPROVED DOOR LEAF SIZES

This graph represents the envelopes of approved leaf sizes for the proposed door leaf constructions and configurations. Any combination of leaf width and height that falls within the graph axes and the connecting line on the graph are approved for the specific construction.

POINT A represents the maximum leaf height and it associated width. POINT B represents the maximum leaf width and it associated height.

This figure forms part of International Fire Consultants Ltd's Field of Application Report PAR/1 2033/01, which contains full details of the assessed doorset constructions.

Configuration  
**Timber Frames**  
 UNLATCHED  
 SINGLE ACTING  
 SINGLE LEAF  
 WITH or WITHOUT TRANSOMMED OVERPANEL  
 REQUIRED INTEGRITY : 30 Minutes

This drawing is Copyright©  
 Contractors must check all dimensions.  
 Any discrepancies must be reported before  
 work proceeds.  
 Only work to dimensions stated on drawing.

### INTERNATIONAL FIRE CONSULTANTS LTD

20 Park Street  
 PRINCES RISBOROUGH  
 Buckinghamshire  
 HP27 9AH  
 United Kingdom  
 Tel: +44 (0) 1844 275500  
 Fax: +44 (0) 1844 274002  
 Email: ifc@intfire.com  
 Website: <http://www.intfire.com>

Field of Application Report PAR/1 2033/01  
 Acoustic and Fire Door Solutions Ltd  
 TrnSound dB+ FD30 Timber-Based  
 Three Layer Door Leaves  
 Installed in Timber Frames

Envelope of Approved  
 Door Leaf Sizes

Job number : 1 2033  
 Drawn by : C5P | Checked by : DJC  
 Not To Scale | July 2012

PAR/1 2033/01 :03

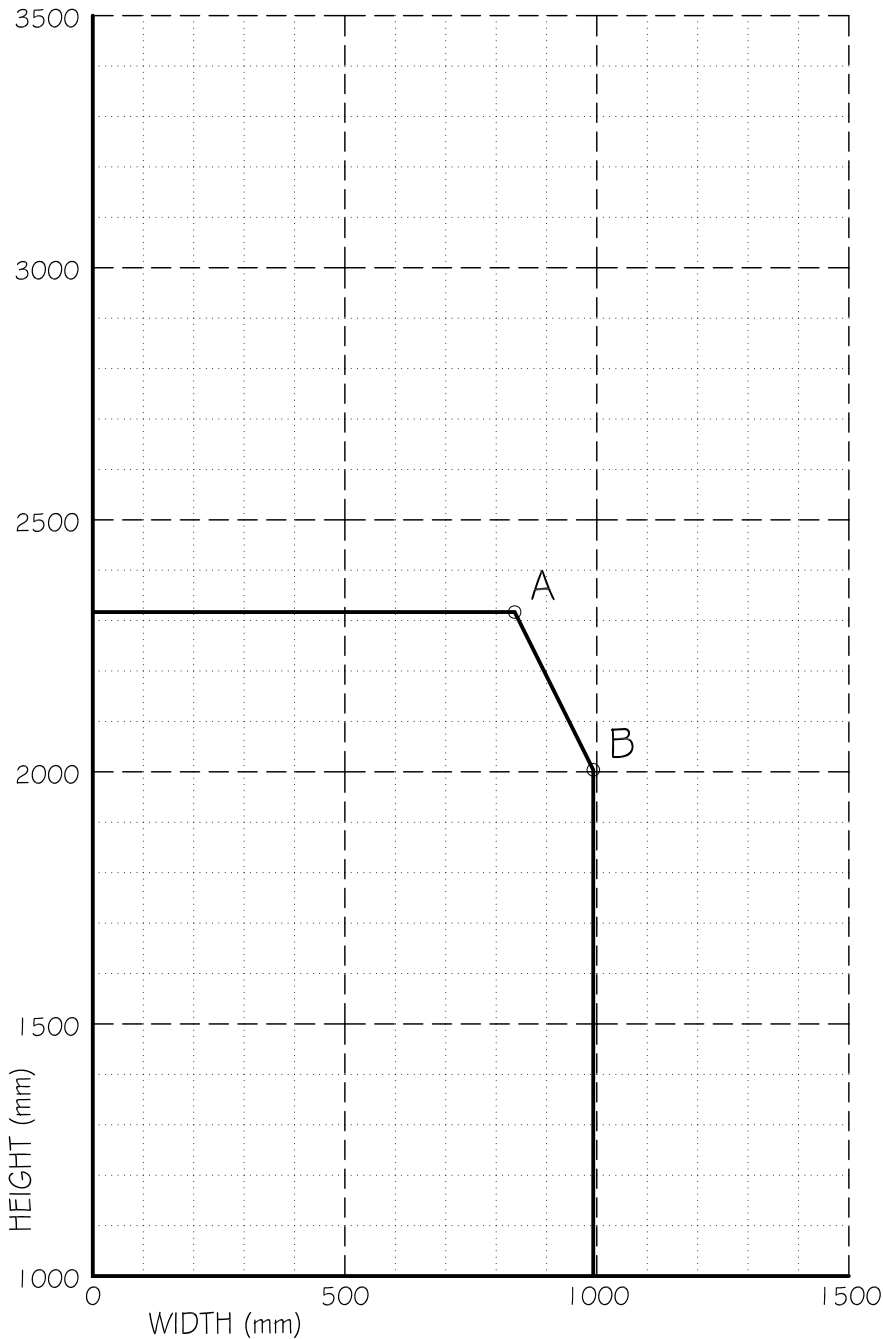

LSADD		
-----		
	A	B
Width	837	993
Height	2317	2004

### ENVELOPE OF APPROVED DOOR LEAF SIZES

This graph represents the envelopes of approved leaf sizes for the proposed door leaf constructions and configurations. Any combination of leaf width and height that falls within the graph axes and the connecting line on the graph are approved for the specific construction.

POINT A represents the maximum leaf height and it associated width. POINT B represents the maximum leaf width and it associated height.

This figure forms part of International Fire Consultants Ltd's Field of Application Report PAR/1 2033/01, which contains full details of the assessed doorset constructions.

Configuration  
**Timber Frames**  
 LATCHED  
 SINGLE ACTING  
 DOUBLE LEAF  
 WITH or WITHOUT TRANSOMMED OVERPANEL  
 REQUIRED INTEGRITY : 30 Minutes

This drawing is Copyright©  
 Contractors must check all dimensions.  
 Any discrepancies must be reported before  
 work proceeds.  
 Only work to dimensions stated on drawing.

### INTERNATIONAL FIRE CONSULTANTS LTD

20 Park Street  
 PRINCES RISBOROUGH  
 Buckinghamshire  
 HP27 9AH  
 United Kingdom  
 Tel: +44 (0) 1844 275500  
 Fax: +44 (0) 1844 274002  
 Email: ifc@intfire.com  
 Website: <http://www.intfire.com>

Field of Application Report PAR/1 2033/01  
 Acoustic and Fire Door Solutions Ltd  
 TrnSound dB+ FD30 Timber-Based  
 Three Layer Door Leaves  
 Installed in Timber Frames

Envelope of Approved  
 Door Leaf Sizes

Job number : 1 2033  
 Drawn by : C5P | Checked by : DJC  
 Not To Scale | July 2012

PAR/1 2033/01 :04



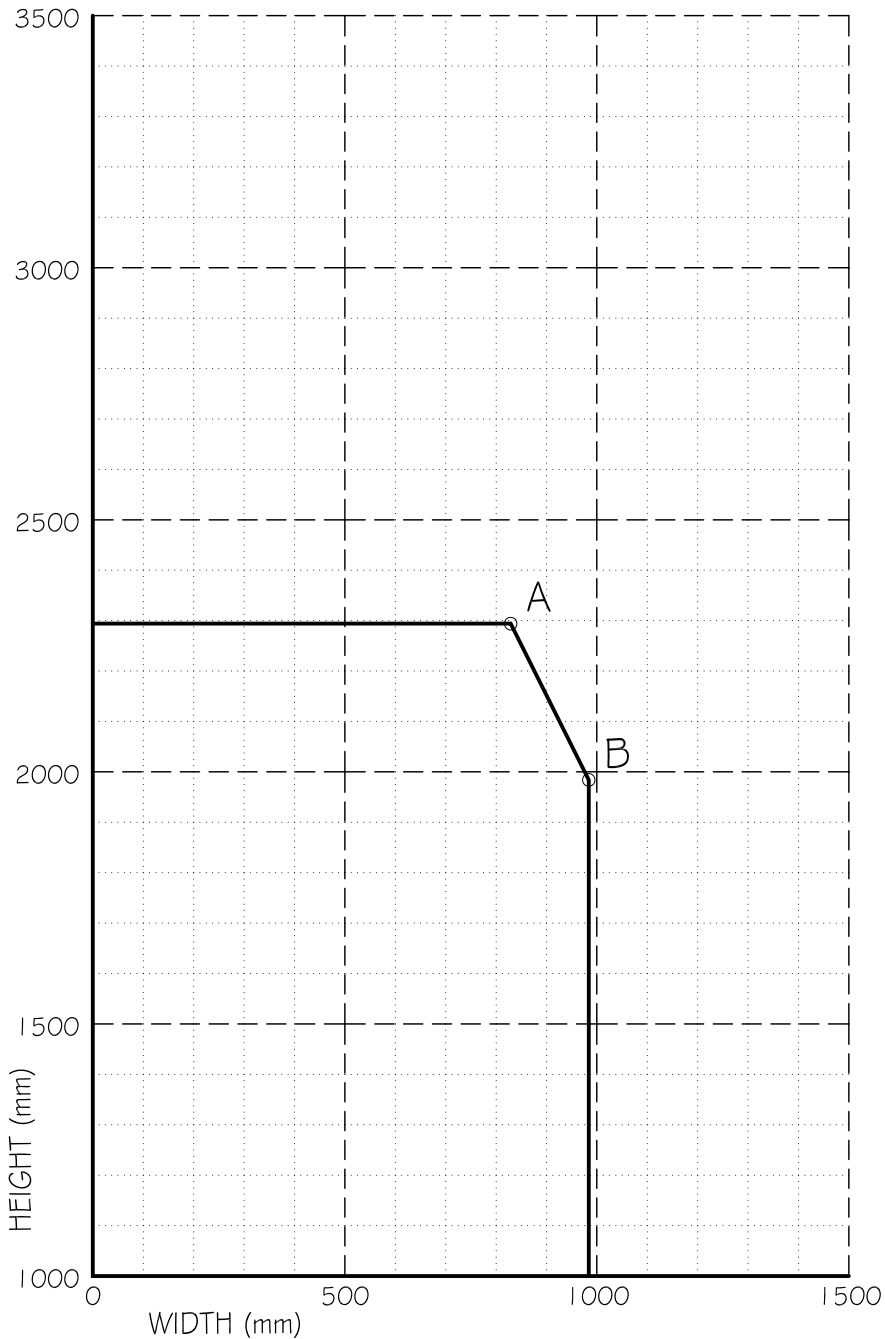

ULSADD		
-----		
	A	B
Width	829	984
Height	2294	1984

### ENVELOPE OF APPROVED DOOR LEAF SIZES

This graph represents the envelopes of approved leaf sizes for the proposed door leaf constructions and configurations. Any combination of leaf width and height that falls within the graph axes and the connecting line on the graph are approved for the specific construction.

POINT A represents the maximum leaf height and it associated width. POINT B represents the maximum leaf width and it associated height.

This figure forms part of International Fire Consultants Ltd's Field of Application Report PAR/1 2033/01, which contains full details of the assessed doorset constructions.

Configuration  
**Timber Frames**  
 UNLATCHED  
 SINGLE ACTING  
 DOUBLE LEAF  
 WITH or WITHOUT TRANSOMMED OVERPANEL  
 REQUIRED INTEGRITY : 30 Minutes

This drawing is Copyright©  
 Contractors must check all dimensions.  
 Any discrepancies must be reported before  
 work proceeds.  
 Only work to dimensions stated on drawing.

### INTERNATIONAL FIRE CONSULTANTS LTD

20 Park Street  
 PRINCES RISBOROUGH  
 Buckinghamshire  
 HP27 9AH  
 United Kingdom  
 Tel: +44 (0) 1844 275500  
 Fax: +44 (0) 1844 274002  
 Email: ifc@intfire.com  
 Website: <http://www.intfire.com>

Field of Application Report PAR/1 2033/01  
 Acoustic and Fire Door Solutions Ltd  
 TrnSound dB+ FD30 Timber-Based  
 Three Layer Door Leaves  
 Installed in Timber Frames

Envelope of Approved  
 Door Leaf Sizes

Job number : 1 2033  
 Drawn by : C5P | Checked by : DJC  
 Not To Scale | July 2012

PAR/1 2033/01 :05

## **APPENDIX E**

### **General Guidance on Installation of Hardware**

## General Guidance on Installation of Hardware

### E.1 Hinges

The doorsets have been tested utilising Royde & Tucker Hi-Load 105 hinges which are thus proven to make a positive contribution to the required 30 minutes integrity performance. Other makes of hinge may be used as alternatives providing they comply with the following specification:

Hinge types: Fixed pin, washered butt, ball bearing butt, lift-off type or journal supported hinges may be used.

Number of hinges: 3no (1½ pairs) per leaf

Positions: The top hinge must be positioned 120–180mm down from the head of the leaf to the top of the hinge and the bottom hinge positioned 200–250mm up from the foot of the leaf to the bottom of the hinge. The middle hinge(s) must be either equispaced between the top and bottom hinge, or 200–250mm below the top hinge.

Fixings: Steel screws, as recommended by the hinge manufacturers, but in no case smaller than No 8 (3.8mm diameter) by 32mm long, and having thread for the full length. Position of screws (in relation to the door face) in blades of alternative hinge types shall be similar to hinges tested with the proposed door type.

Hinge blade sizes: 2.5–3.5mm thick by 89–110mm high by 30–35mm width. (These dimensions refer to the blade size, i.e. the part of the hinges that are recessed into the edge of the leaves/frame.)

Hinge materials: Brass, Phosphor Bronze, Steel or Stainless Steel. (Aluminium, Nylon or 'Mazac' are not permitted.) No combustible or thermally softening materials to be included.

Additional protection: Not required

Rising butt, non-cranked butts and spring hinges are not suitable for use on doors approved within the scope of this generic assessment, although they may be suitable on the basis of an individual and specific fire engineering evaluation.

### E.2 Mortice Latches/Locks

The doorset have been tested with an Allgood 7186 mortice deadlock centrally fitted in the nib of unequally rebated edge meeting stiles. This deadlock is thus proven to make a positive contribution to the required 30 minutes integrity performance. Other mortice latches/locks may be used, subject to compliance with the specifications below:

Latch/lock types:	Mortice latches, tubular mortice latches, sashlocks, deadlocks
Positioning:	Centred at 1000mm ( $\pm$ 200mm), above the bottom of the door leaf
Maximum dimensions:	Forend plate: 235mm long x 20mm wide or 200mm long x 25mm wide Latch body: 20mm thick x 165mm high x 100mm wide Strikeplate: 235mm long x 20mm wide or 200mm long x 25mm wide
Materials:	Latches must have no essential part of their structure made from polymeric or other low melting point (<800°C) materials, and should not contain any flammable materials.
Additional protection:	Not required

Over-morticing is to be avoided; mortices should be as tight as possible to the latch. If gaps around the case exceed 2mm, then these must be made good with intumescent mastic or sheet material. Holes for spindles or cylinders should be kept as small as is compatible with the operation of the hardware.

Where glazing apertures are also incorporated, and are positioned such that locks/latches are included in the margin between the aperture and door edge, care must be taken to ensure that the effective door 'stile' is not weakened by the mortice. It is a condition of this assessment that, except where tubular latches are employed, the margin must be at least 75mm wider than the lock/latch mortice. If the mortice latch/lock is fitted in line with a 'rail' between two apertures, no part of the lock mortice shall be closer than 50mm to the edge of any aperture.

### **E.3 Door Closers**

Where required by regulatory guidance or specific fire strategy each hinged door leaf must be fitted with an overhead surface mounted self-closing device unless it is normally kept locked shut and labelled as such with an appropriate sign which complies with BS5499: Part 1: 1990.

Concealed overhead and jamb mounted closers are not permitted in the doorsets covered by this Field of Application Report.

The door closer should have been incorporated in a successful fire resistance test to BS 476: Part 22: 1987 when fitted to the exposed face of an unlatched timber door assembly, and/or have been assessed to be suitable for inclusion in a timber fire resisting doorset. It should fulfil the requirements of BS EN 1154: 1997 and have a minimum power size of 3.

The closing force of the closer must be sufficient to overcome the resistance of the latch, and smoke seals where fitted. The closer may not be used in any mode of operation which requires any part of the closer to penetrate the gap between the door and the frame, or which requires the stop to be interrupted or morticed.

## E.4 Flush Bolts

The doorset have been tested with Allgood 48800FQ flush bolts centrally fitted in the passive leaf edge at the meeting stiles. These flush bolts are thus proven to make a positive contribution to the required 30 minutes integrity performance. Other flush bolts may be utilised subject to compliance with the specifications below:

- All bolts shall be steel, unless specific fire test evidence is available;
- Maximum size of flush bolt is 250mm long x 20mm wide and 19mm deep;
- The head of the leaf and/or frame should contain a minimum 5mm width of intumescent material local to the bolt/keep plate;
- The body of the bolt should be bedded on non-pressure forming intumescent material at least 1mm thick;
- Edge fixed bolts shall be positioned centrally in the leaf thickness (the intumescent seals defined in Appendix D shall be fitted in the active leaf);
- There should be a minimum of 5mm width of intumescent strip in the door edge, past the body of the bolt;
- Flush bolts are not approved on doors with rebated overpanels, since this will clash with the rebate alignment. Surface mounted bolts may be used; see below;
- Face fixed flush bolts shall be fixed so that there is a minimum of 50mm between the bolt and the door edge;
- Surface mounted barrel bolts shall not exceed 400mm in length, but there is no limitation on their width. Screws for fixing bolts must be at least 25mm long, and have thread for the full screw length.

## E.5 Non-Essential Hardware Items

### E.5.1 Dropseals

The doorset was tested with a Norsound NOR 810 drop seal fitted 10mm from the exposed face of the leaves. This dropseal is thus proven to make a positive contribution to the required 30 minutes integrity performance.

Norsound NOR 810 drop seals can be utilised without additional intumescent protection if the intumescent seals are in the frame reveal, or encased in 1mm thick Intumescent Seals Ltd Therm-A-Strip or an alternative 1mm thick low-pressure intumescent gasket if the intumescent seals are in the leaf edges. At meeting stiles at least a total of 10mm width of seal should be continuous alongside the drop seal.

### E.5.2 Letter plates

Letter plates must be tested, assessed or otherwise approved for use in minimum 44mm thick cellulosic FD30 doors. They must be fitted in accordance with the manufacturer's instructions, including all intumescent liners and flaps. Plates must not be less than 100mm away from the leaf edge, or any other aperture.

*Note E1 The installation of such items in a door leaf may compromise its performance as a smoke control doorset.*

### ***E.5.3 Push plates, kick plates, etc***

Plastic, pvc or metal plates may be surface-mounted to the doorsets, but, if more than 800mm in length by nominally 200mm wide, they must be attached in a way that would prevent them distorting the door leaf, e.g. glued with thermally softening adhesive or screwed with short aluminium screws and fitted in such a way so they will not be prevented from falling away by being trapped under door stops, glazing beads or handle escutcheons etc.

### ***E.5.4 Pull handles***

Pull handles may be fixed to the doorsets, provided that the fixing points are no greater than 1065mm apart. Pull handles that are fixed through the leaf should use clearance holes as close fitting as possible to the bolt.

### ***E.5.5 Intumescent air transfer grilles***

Intumescent air transfer grilles must be tested, assessed or otherwise approved for use with minimum 44mm thick cellulosic FD30 doors. They must be fitted fully in accordance with the manufacturer's instructions, including all intumescent liners and cloaking grilles/beads. They must be no larger than that for which test or assessment evidence exists. See Section 3.5.4, for restrictions on maximum size and placement of any apertures; these apply to those for grilles, which must also be included in the total area permitted for apertures given in Section 3.5.4.

*Note E2 The installation of such items in a door leaf may compromise its performance as a smoke control doorset.*

### ***E.5.6 Security viewers***

Security viewers may be fixed into the proposed doors, subject to the following limitations, unless specific fire test evidence exists to the contrary;

- Viewers must not exceed 15mm outer diameter, and be made from brass or steel;
- Holes bored through the door must be no greater than 1mm larger than the bore of the viewer and must be lined with a non-pressure forming intumescent mastic/sheet;
- The viewer must include an effective shutter/cover plate.

## **APPENDIX F**

### **Summary of Fire Test Evidence**

## Summary of Fire Test Evidence

Test Report	Configuration Tested	Leaf Size Tested	Integrity
CFR1002031	ULSADD	2100 x 927 + 926 x 54mm	16 minutes *
WF 164432A	LSASD	2078 x 992 x 44mm	40 minutes

\* *Integrity failure occurred due to delayed intumescent seal activation at the head of the doorset. The intumescent seal specification has been revised in order to mitigate against this failure and maintain integrity for 30 minutes under the conditions of a BS476: Part 22: 1987 fire resistance test.*

**ULSADD** = Unlatched, Single Acting, Double leaf Doorset  
**LSASD** = Latched, Single Acting, Single leaf Doorset

### Note:

Where appropriate, fire test evidence from glass, hardware, and intumescent seal manufacturers has also been considered when preparing this Field of Application Report.